

HMF 6020-K



- power to lift.

HMF 6020-K

Loading group B3		6020-OK2	6020-OK3	6020-OK4	6020-OK5	6020-OK6	6020-K6	6020-K7	6020-K8
Load moment	tm	56.6	55.1	54.1	53.4	52.7	52.9	52.3	51.6
Hydraulic reach	m	8.3	10.4	12.4	14.7	17.0	15.8	18.2	20.6
Slewing torque	kgm	7000	7000	7000	7000	7000	7000	7000	7000
Slewing angle	°	cont.	cont.	cont.	cont.	cont.	cont.	cont.	cont.
Height above chassis	mm	2425	2425	2425	2425	2425	2425	2425	2425
Width, folded	mm	2500	2500	2500	2500	2500	2500	2500	2500
Length of loader, no extra valves	mm	1325	1325	1325	1325	1325	1460	1460	1460
Stabilizer spread, standard	mm	6325	6325	6325	6325	6325	8420	8420	8420
Stabilizer spread, long	mm	8420	8420	8420	8420	8420	6325	6325	6325
Weight excl. stabilizers	kg	4415	4715	5015	5285	5525	5465	5665	5865
Weight of stabilizers, standard	kg	700	700	700	700	700	700	700	700
Working pressure	MPa	35.0	35.0	35.0	35.0	35.0	35.0	35.0	35.0
Pump performance	l/min	1 x 80 / 1 x 120 / 2 x 65 / 2 x 110							
Oil tank capacity, separate tank	l	210-420							
Power consumption	kW	48-122							
Hook height 1.5 m from column	m	3.2	3.1	3.0	2.9	2.8	3.1	2.8	2.8

HMF 6020-K6

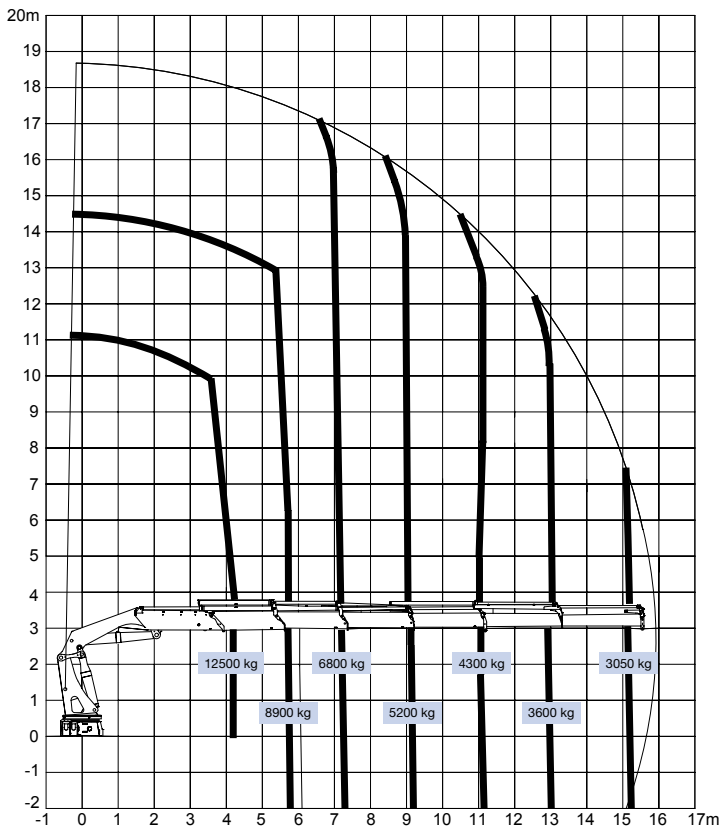

HMF 6020-K8

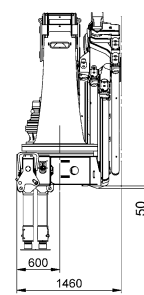
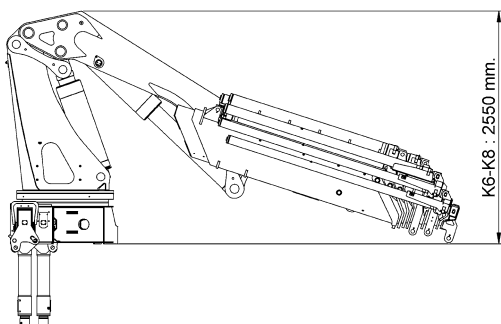
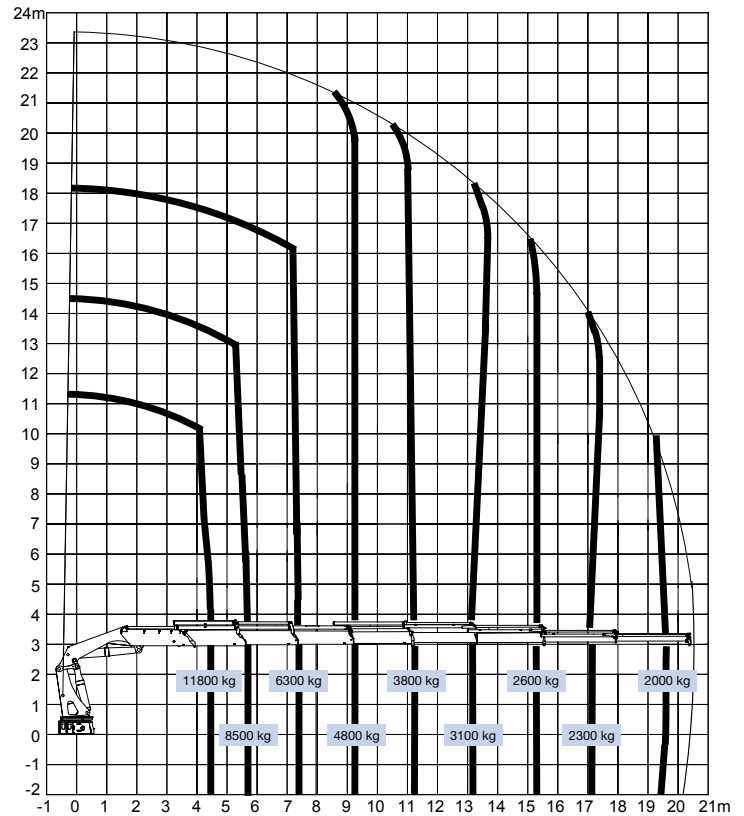

HMF 6020-K6
HMF 6020-K8

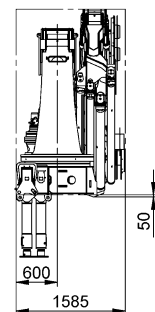

HMF 6020-K6
+ FJ 1200-K6

6020-OK6 + FJ1200-K6

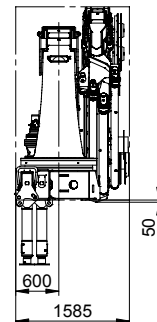
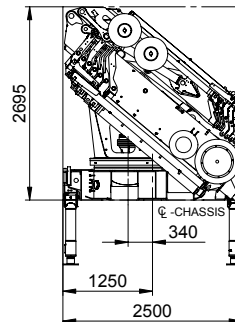
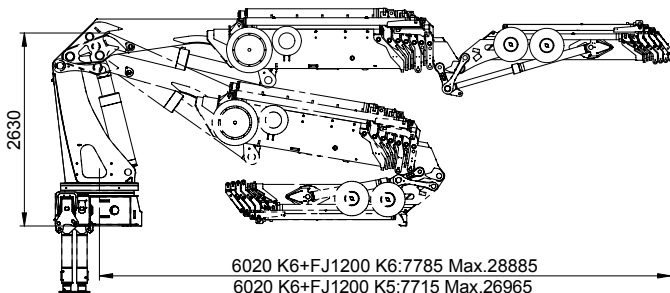
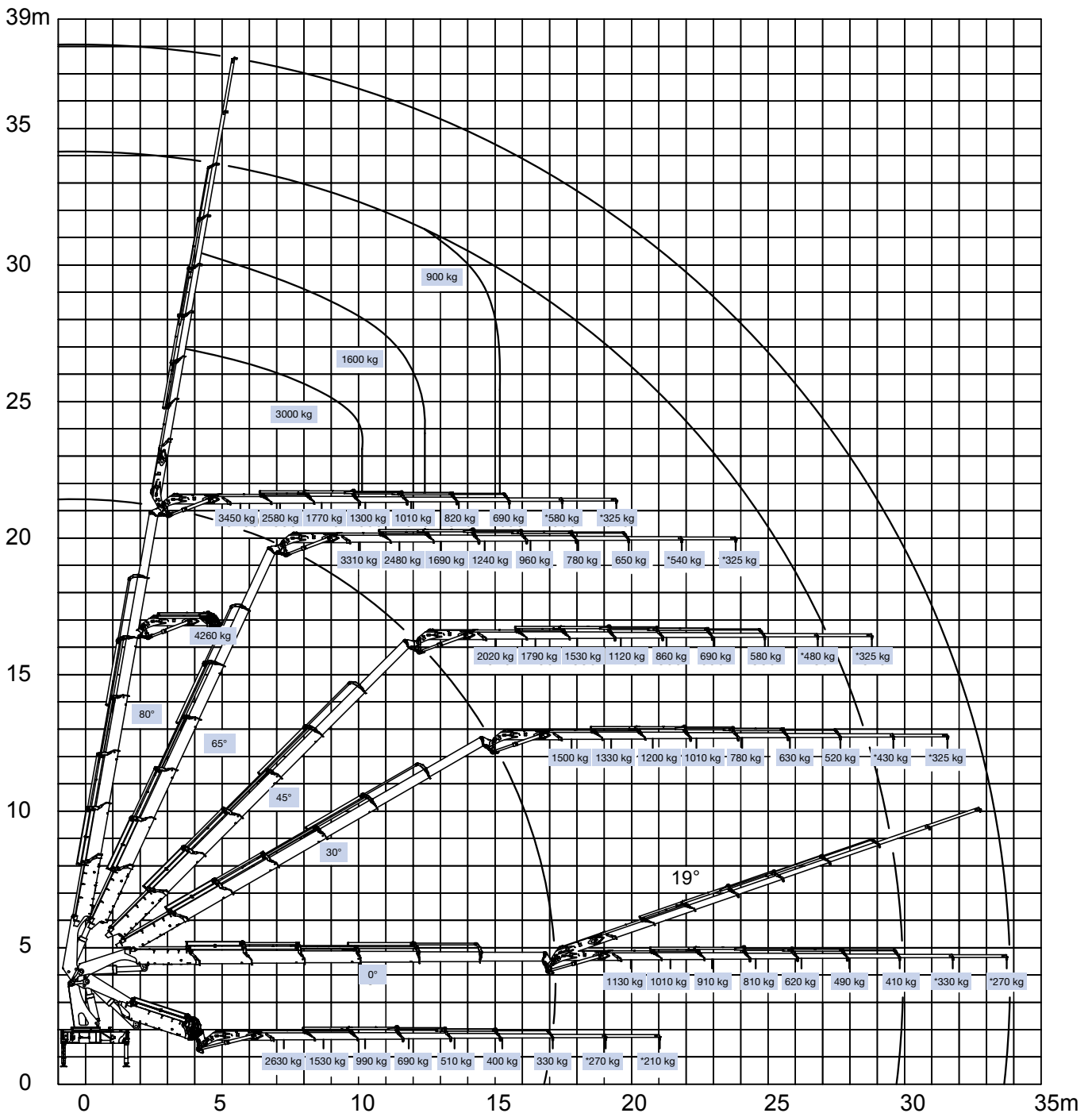

- power to lift.

HMF 6020-K



HMF 6020-OK2		kg	12630	8950	6910									
		m	4,5	6,3	8,2									
HMF 6020-OK3		kg	12300	8650	6610	5310								
		m	4,5	6,3	8,2	10,2								
HMF 6020-OK4		kg	12140	8440	6370	5050	4170	3100	2525	2075				
		m	4,5	6,3	8,2	10,2	12,3	14,5	16,9	19,4				
HMF 6020-OK5		kg	11780	8140	6100	4800	3920	3310	2475	2025	1700			
		m	4,5	6,4	8,3	10,3	12,4	14,6	16,8	19,3	21,9			
HMF 6020-OK6		kg	11500	7900	5860	4560	3680	3080	2640					
		m	4,6	6,4	8,3	10,3	12,4	14,6	16,9					
HMF 6020-K6		kg	12070	8540	6470	5100	4160	3470	2980	2200	1825	1525		
		m	4,4	6,0	7,7	9,5	11,4	13,5	15,6	18,0	20,5	23,0		
HMF 6020-K7		kg	11450	8110	6130	4870	3890	3210	2730	2370	1775	1475	1200	
		m	4,6	6,2	7,9	9,7	11,6	13,7	15,8	18,1	20,4	22,9	25,4	
HMF 6020-K8		kg	11210	7900	5910	4600	3690	3010	2530	2170	1910	1425	1150	900
		m	4,6	6,3	8,0	9,8	11,7	13,7	15,9	18,2	20,5	22,8	25,3	27,9

▽ Lifting capacity without manual extensions
 ▼ Lifting capacity with manual extensions

Z008457-1



Højbjerg Maskinfabrik A/S • Oddervej 200 • DK-8270 Højbjerg
 Tel.: +45 8627 0800 • Fax: +45 8627 0744 • info@hmf.dk

www.hmf.dk

We reserve the right to introduce improvements and modifications